

## 4x DALI-2 RM16 I

### Datasheet

#### DT7 Relay Module

Relay Module for the integration of non-dimmable ballasts in DALI lighting systems (DT7)

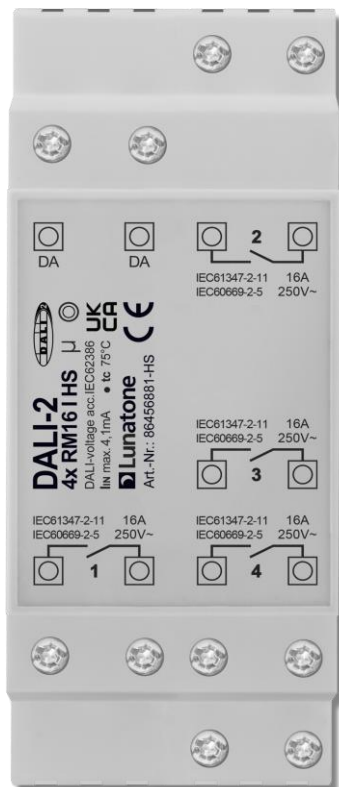

4x RM16 I HS

Art.Nr. 86456881-HS

**RM16 I HS**  
inrush current up to  
350A

# 4x DALI-2 RM16 I Relay Module

## Overview

- 4 Relay Contact Modul for the direct control of 230V AC loads via DALI
- Ballasts without DALI-input can be simply integrated in a DALI lighting control system. The loads can then be switched ON and OFF by DALI commands.
- The module fulfils the requirements for DALI Device Type 7 - switching function
- Configurable Power-Up and System-Failure behaviour
- Easy configuration via Lunatone DALI USB interface and DALI-Cockpit Software Tool (suitable interface modules: [DALI-2 USB](#); [DALI USB](#), [DALI-2 WLAN](#), [DALI-2 Display](#), [DALI-2 IoT](#), [DALI 4Net](#), [DALI SCI RS232](#)).The 4x RM16 I is supplied directly by the DALI signal line
- The 4x DALI-2 RM16 I is supplied directly by the DALI signal line, no additional power supply necessary
- Zero cross switching
- inrush currents up to 350A
- The modules represents 4 DALI ballast on the DALI line.



## Specification, Characteristics

<b>type</b>	<b>DALI-2 4x RM16 I HS</b>
article number	86456881-HS
<b>electrical data</b>	
supply	via DALI line
typ. current consumption	4.1 mA
relay output switch on/off voltage	277 Vac
max. nominal load circuit breaker	3000VA 16A max
max. breaking current	20A
max. inrush current	350A
max. continuous current	16A
switching method	zero cross switching
type of relay contact	normally open
switching operations at nominal load, resistive	>10 <sup>5</sup>
maximum switching frequency	1Hz
input	DALI
number of used DALI addresses	4



## Typical Application

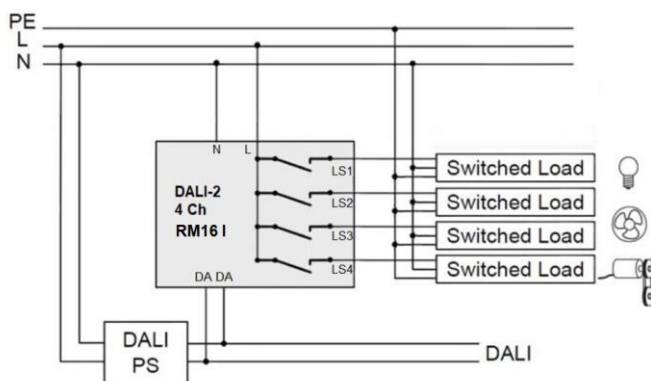

**Hint:** To ensure that the load current does not exceed the maximum switching current, the installation must be secured with a suitable automatic circuit breaker

## Factory Default Settings

A basic configuration is already implemented on delivery (factory default setting). If necessary, this can be changed and adapted.

	Factory default for all 4 relays	DALI Standard
Min Level	0,1%	100%
Max Level	100%	100%
Power on Level	100%	100%
System Failure Level	none	100%
Fade Time	44.7 steps/s (= 7)	none
Fade Rate	all scenes: MASK	44.7 steps/s
Scene values:	set DALI Standard values, see column 2	all scenes: MASK
Behaviour at DALI RESET command	disabled	N/A (remains unchanged)
Ignore broadcast commands	0.1%	N/A (remains unchanged)
Dim UP switch ON threshold	MASK	N/A (remains unchanged)
Dim UP switch OFF threshold	MASK	N/A (remains unchanged)
Dim DOWN switch ON threshold	0%	N/A (remains unchanged)
Dim DOWN switch OFF threshold	all scenes: MASK	N/A (remains unchanged)

## Installation

- The DALI-2 4x RM16 I is directly connected and supplied by the DALI bus (A typical value of current consumption is 2.7mA). A DALI bus power supply (e.g. [DALI PS](#)) is required, an additional power supply is not necessary.
- The connection to the DALI terminals can be made regardless of polarity.
- The DALI-line must **not** be connected to the mains or extra low voltage systems.
- The relay output of the RM16 I supports loads up to 2000VA and switching currents up to 16A.
- To ensure that the load current does not exceed the maximum switching current of the relay a suitable automatic circuit breaker has to be installed.
- Switching is done at zero cross of ac voltage.
- The wiring should be carried out as a permanent installation in a dry and clean environment.
- Installation may only be carried out in a voltage-free state of the system and by qualified specialists.

- National regulations for setting up electrical systems must be followed.
- The DALI wiring can be realised with standard low-voltage installation material. No special cables are required.
- Wiring topology of the DALI-line: Line, Tree, Star
- Only 1 wire may be connected to each terminal. When using double wire end ferrules, the connection capacity of the terminal must be considered.

 **Attention:** The DALI-signal is not classified as SELV circuit (Safety Extra Low Voltage). Therefore, the installation regulations for low voltage apply

 The voltage drop on the DALI line must not exceed 2V at maximum length (300m) and maximum bus load (250mA).

## Addressing and Configuration

- After installation the DALI-2 4x RM16 I is ready for use
- The configuration can be done with the help of the [DALI Cockpit Software](#). The PC must be connected to the DALI bus via a suitable interface module ([DALI-2 USB](#); [DALI USB](#), [DALI-2 WLAN](#), [DALI-2 Display](#), [DALI-2 IoT](#), [DALI 4Net](#), [DALI SCI RS232](#)).
- The DALI-2 4x RM16 I is automatically recognised by the DALI Cockpit during the addressing process and listed in the device overview.
- The standard DALI device settings as well as the device specific settings can be configured in the DALI Cockpit, see section "Functionality".
- The "Identify" function can be used for localization after addressing. With the DALI command IDENTIFY or selecting the checkbox "localise" in the DALI Cockpit the relay switches.

### lokalise

The IDENTIFY command should not be used if switching of the relay is not desired. Alternatively, the allocation can also be done via the serial number of the device.

## Functionality

The DALI-2 4x RM16 I acts as a DALI-controlled relay contact. Hence ballasts can be integrated in a DALI-system and switched on and off by DALI commands.

The DALI-2 4x RM16 I acts like a standard DALI ballast for non-dimmable loads. It is based on the DALI specification for control gear (IEC 62386-102) and the device type 7 extension (IEC 62386-208). Therefore, the switching characteristic is determined by the comparison of the virtual direct arc power level (VDAP) with 4 thresholds.

The virtual dim level (VDAP) is like the dim level of DALI-ballasts and is therefore limited by MINLEVEL and MAXLEVEL and influenced by fade-time and fade-rate.

For each dim direction 2 thresholds can be defined. They are compared with the virtual dim level and as a result the output is switched on or off:

virtual dim direction	comparison of virtual dim level and thresholds	output
UP	VDAP >= UP Switch On Threshold	ON
UP	VDAP >= UP Switch Off Threshold	OFF
DOWN	VDAP <= DOWN Switch On Threshold	ON
DOWN	VDAP <= DOWN Switch Off Threshold	OFF

If a threshold value is set to "MASK" the threshold is inactive and does not influence the relay output.

Some examples of switching characteristics below:

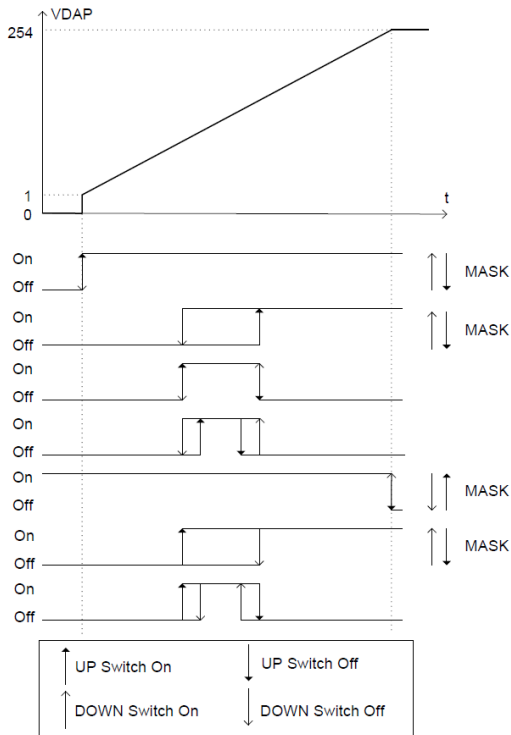

With the help of the fade time switch on and switch off delays can be realized.

**Power-ON and System-Failure behaviour**

The DALI-2 4x RM16 I is bus-powered. The reaction on a system failure can be configured (keep relay state, on or off, factory default: keep state (MASK)). Similarly, the Power On

level can be configured which is applied in case of switching on the DALI-line supply voltage.

**Adjustable RESET behaviour**

From FW 4.6. on the response to a DALI reset command is configurable. The following options are available:

- *Ignore command*: the DALI reset command does not trigger any changes to the device settings
- *DALI standard*: the selected device settings are reset to the values defined in the DALI standard (see table 1 below - second column: DALI standard values)
- *Custom settings*: the current device settings can be saved. With a DALI Reset command, the selected parameters (6 check boxes) are then reset to these saved values.

**Ignore Broadcast Commands**

The broadcast control can be deactivated. Through selection of "Ignore Broadcast", the 4x RM16 I does no longer respond to broadcast commands on the DALI bus (group assignments are not ignored).

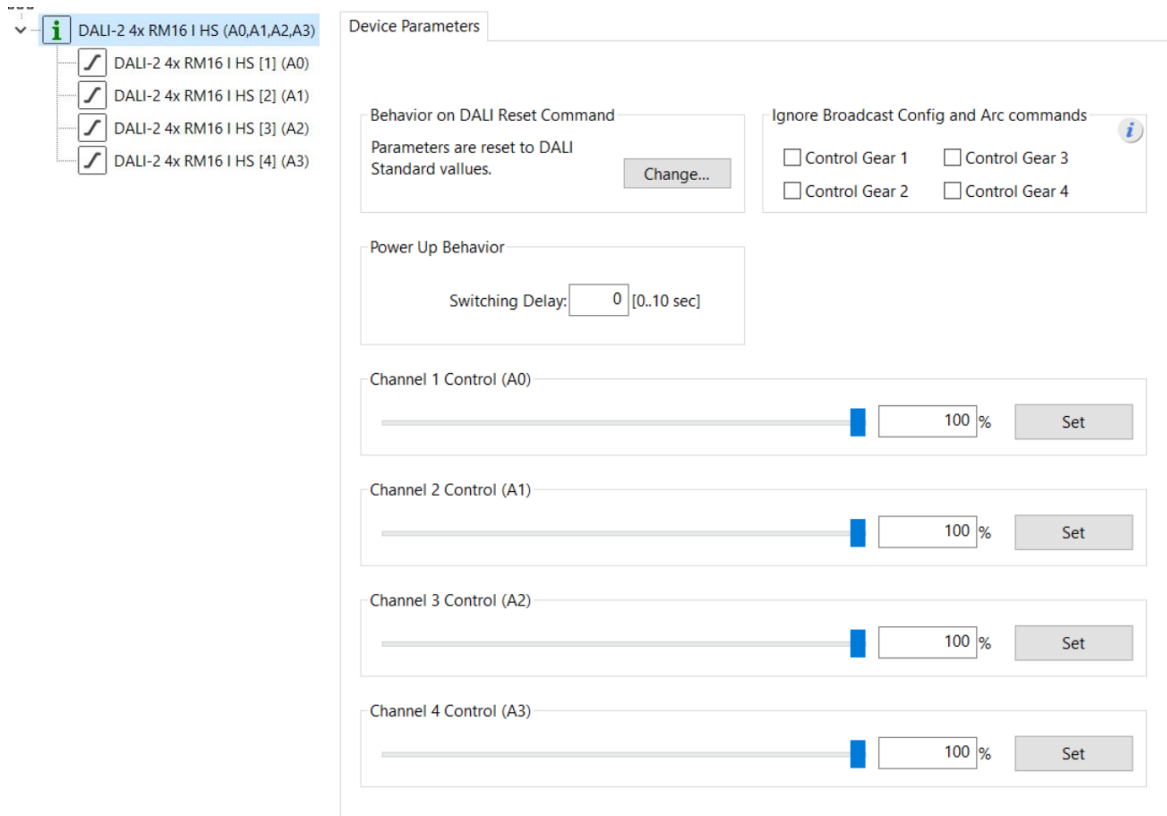

Figure 1 DALI Cockpit device page, all relay contacts

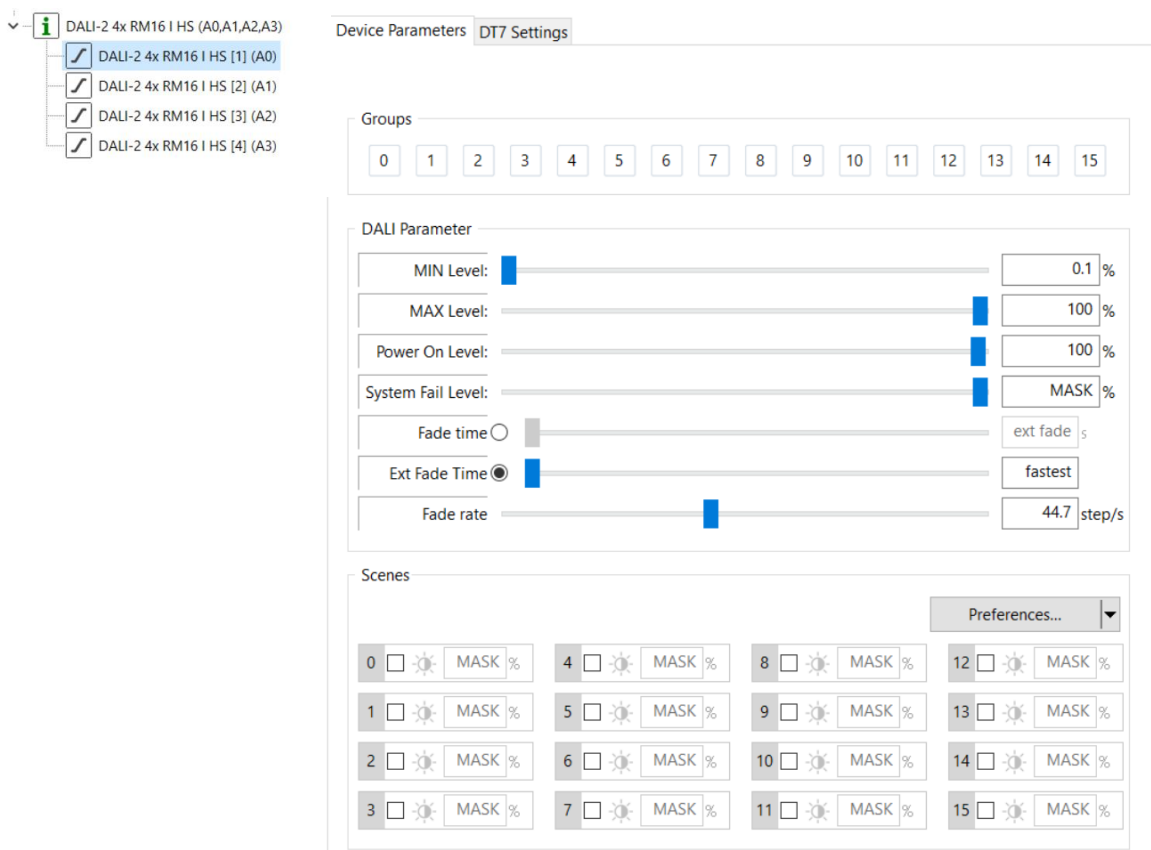

Figure 2 DALI Cockpit, 1. Relay contact, tab: device parameters

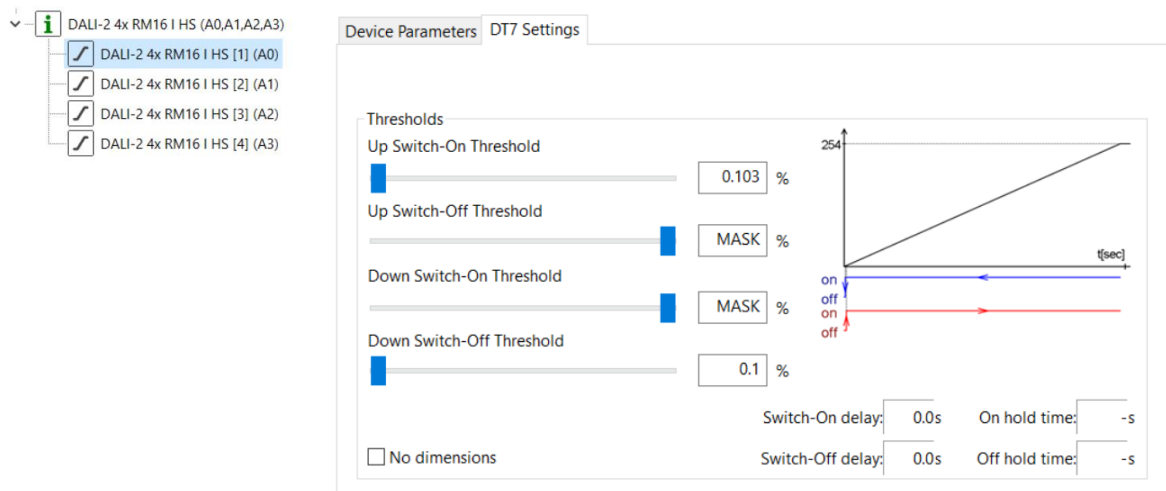

Figure 3 DALI Cockpit, 1. Relay contact, tab: DT7 settings

## Purchase Information

**Art.Nr. 86456881-HS:** DALI-2 4x RM16 I HS, 4 Relay contacts, 3000VA/16A, zero cross switching, normal open, DIN rail mounting

## Contact

Technical Support: [support@lunatone.com](mailto:support@lunatone.com)

Requests: [sales@lunatone.com](mailto:sales@lunatone.com)

[www.lunatone.com](http://www.lunatone.com)

## Additional Information and Equipment

DALI-Cockpit – free configuration tool from Lunatone for DALI systems

<https://www.lunatone.com/en/product/dali-cockpit/>

Lunatone DALI products

<https://www.lunatone.com/en>

Lunatone datasheets and manuals

<https://www.lunatone.com/en/downloads-a-z/>



## Disclaimer

Subject to change. Information provided without guarantee. The datasheet refers to the current delivery.

The compatibility with other devices must be tested in advance to the installation.